

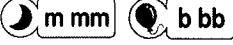









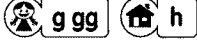
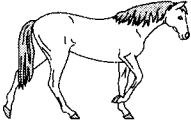

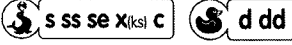
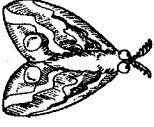

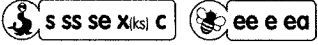



Animals

1 Say the word for the picture. Circle the sound box for the sound at the **start** of the picture name.

2 Say the word for the picture. Finish the word by adding the first letter.

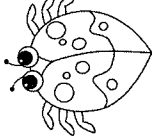
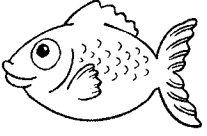
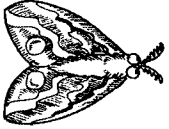



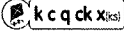

 ___at	 ___at	 ___at
 ___ig	 ___ug	 ___ish
 ___oth	 ___en	 ___uck

3 Draw some animals that start with .

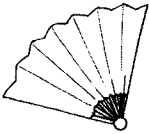

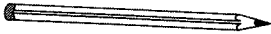
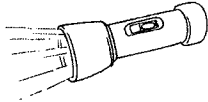



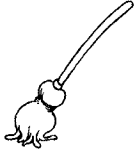

4 Draw some animals that start with .

In My House

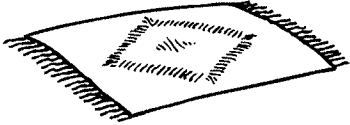
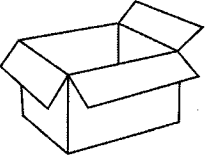
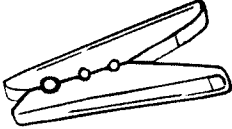
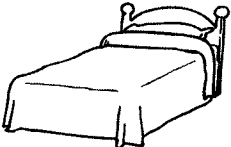
1 Say the word for the picture. Circle the sound box for the sound at the end of the picture name.

 <p>fff ggg</p>	 <p>m mm n nn</p>	 <p>sh s ss se x(ks) c</p>
 <p>zzz s m mm</p>	 <p>ppp ll</p>	 <p>sh ch</p>
 <p>fff ttt</p>	 <p>k c q ck x(ks) g gg</p>	 <p>ttt h</p>

2 Say the word for the picture. Finish the word by adding the last letter.

 <p>mo__</p>	 <p>pa__</p>	 <p>ja__</p>
 <p>ma__</p>	 <p>bo__</p>	 <p>pe__</p>
 <p>be__</p>	 <p>ju__</p>	 <p>bi__</p>
 <p>co__</p>	 <p>ha__</p>	 <p>cu__</p>

Maddy's Maze

Help Maddy find her pet mouse. Follow the instructions to find a path from Maddy to her mouse.

Say the word for each picture.

Colour the space if you hear  in the picture name.











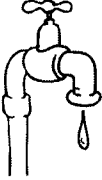
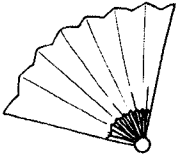





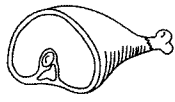

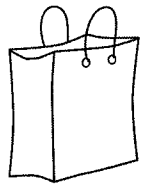
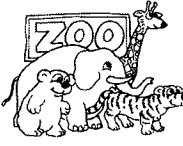
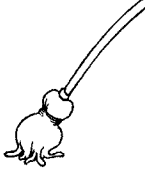
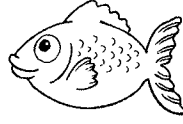
Colour the space if you hear  in the picture name.

Colour the space if you hear  in the picture name.

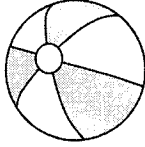
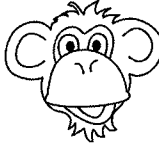
Colour the space if you hear  in the picture name.

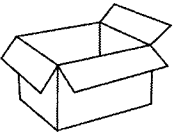
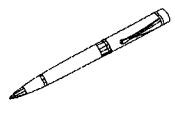
Colour the space if you hear  in the picture name.

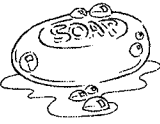
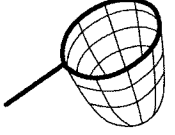

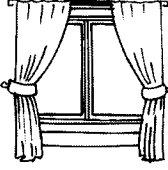
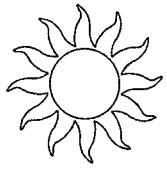
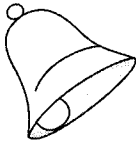
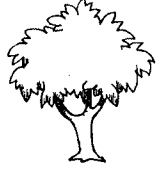







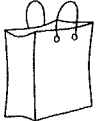

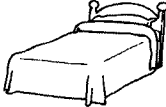



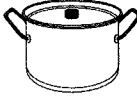
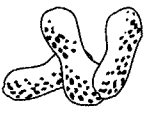



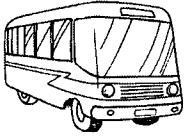
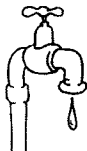

Which Word?

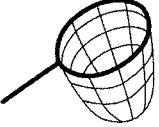
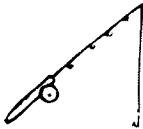
Say the words. Circle the right word for the picture.

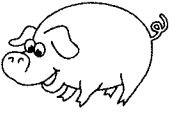
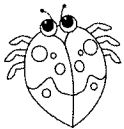
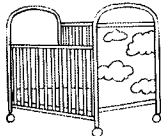
 cat bat sat	 bat bag bad
 ten pen men	 beg bed bet
 zip hip lip	 big bit bin
 mop top hop	 pop pot pod
 but hut nut	 bun bug but

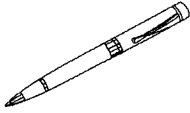
Which Letter?

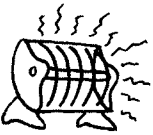
Finish each word with a, e, i, o, or u.

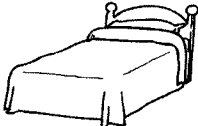
 b__s	 t__p	 c__p
 n__t	 r__d	 s__d
 p__g	 b__g	 c__t
 j__m	 p__n	 h__ll
 h__t	 h__t	 b__d

Balloons

In each balloon, join the words to the correct pictures.

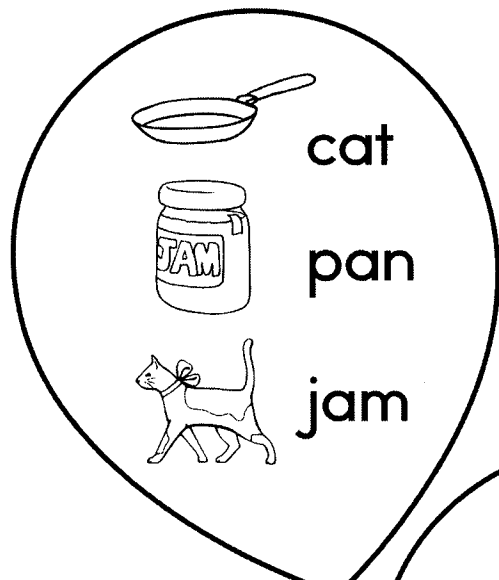

cat
pan
jam

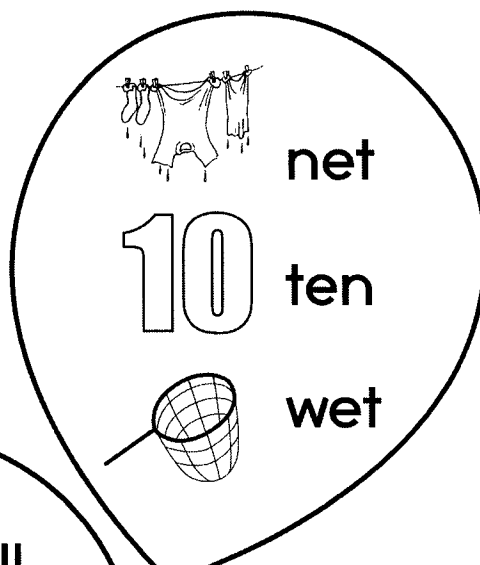

net
10 ten
wet

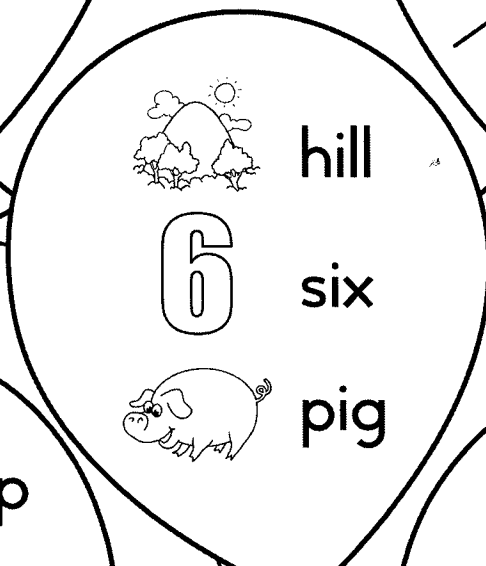

hill
6 six
pig

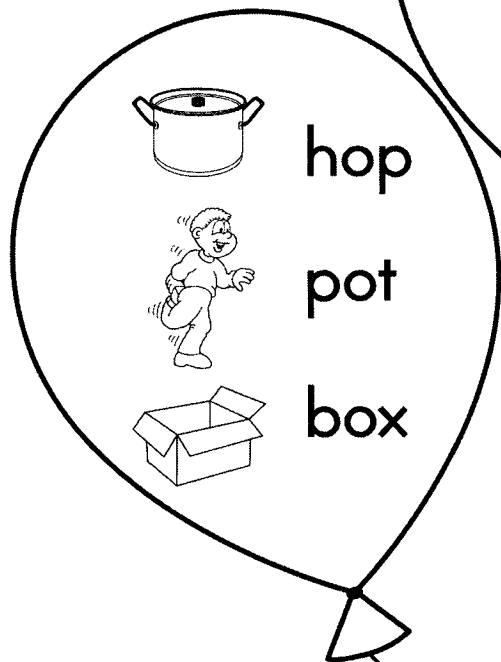

hop
pot
box

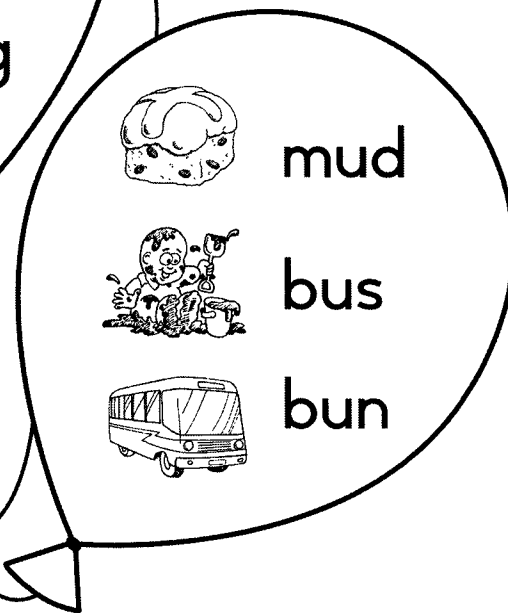

mud
bus
bun



Cross Off

Say the sound for the sound box. **Cross** off the picture that doesn't have that sound in the picture name.

